

版次	变更内容	审核	日期

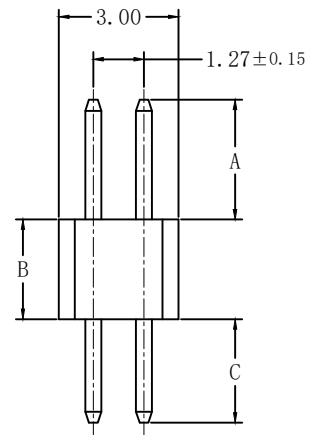
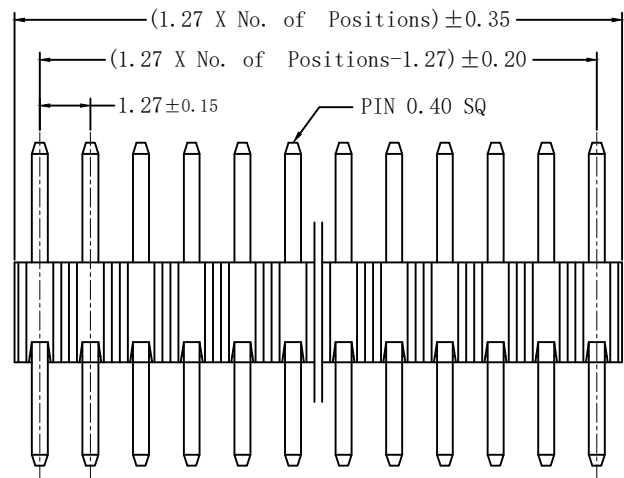

EC127D-S-2*xxP G-A/ B /C

芯数 _____ 针长(可订制)
01~50P

电镀 _____ 塑胶高度
G: 镀金Gold Flash 1.5: 1.5mm
1G: 镀金1u" 2.5: 2.5mm
3G: 镀金3u"
(镀金可订制)

针长(可订制) _____

弯曲度: 2*02P ~ 2*20P 0.30 MAX.
2*21P ~ 2*35P 0.40 MAX.
2*36P ~ 2*50P 0.50 MAX.

技术参数: SPECIFICATIONS

额定电流 (Current Rating): 1A
绝缘电阻 (Insulation Resistance): 1000MΩ Min.
额定电压 (Dielectric Withstanding Voltage): AC 500V
工作温度 (Operating Temperature): -40°C ~ +105°C
最大加工温度 (Max Processing Temp): (230°C for 30~60 seconds)
(260°C for 10 seconds)

接触材料 (Contact Material): 黄铜(Brass)
塑胶材料 (Insulator Material): 尼龙(Nylon)-9T, UL 94V-0; 颜色: 黑色
接触电镀 (Contact Plating): 镀金 (Gold plated)
(电镀规格可根据客户要求来定制)
Optional plating on request.

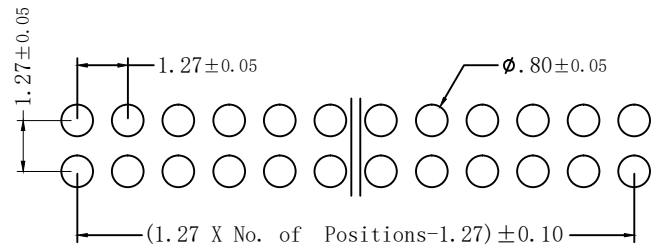

Recommended PCB Layout

公差:	版次:	A		易芯精密科技(浙江)有限公司 Easychips Precision Technology (Zhejiang) Co., Ltd.	型号: EC127D-S-2*xxPG-A/B/C 描述: 1.27双排直脚排针	签名	日期
. X ±0.35 . XX ±0.25 . XXX ±2° LNLGB	比例:					绘图:	
	单位:	mm	确认:				
	页码:	1/2	审核:				
	图号:						

版次	变更内容	审核	日期

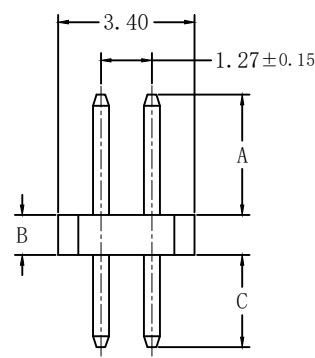
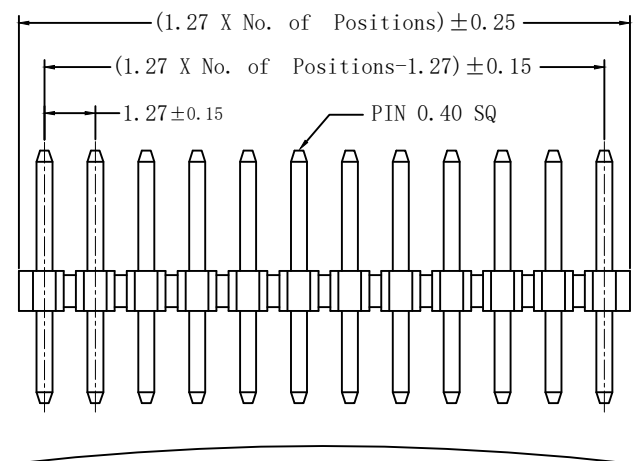

EC127D-S-2*xxP G-A/ B /C

芯数 ———— 针长(可订制)
01~50P

电镀 ———— 塑胶高度
G: 镀金Gold Flash
1G: 镀金1u"
3G: 镀金3u"
(镀金可订制)
1.0: 1.0mm

针长(可订制) ————

弯曲度: 2*02P ~ 2*20P 0.30 MAX.
2*21P ~ 2*35P 0.40 MAX.
2*36P ~ 2*50P 0.50 MAX.

技术参数: SPECIFICATIONS

额定电流 (Current Rating): 1A
 绝缘电阻 (Insulation Resistance): 1000MΩ Min.
 额定电压 (Dielectric Withstanding Voltage): AC 500V
 工作温度 (Operating Temperature): -40°C ~ +105°C
 最大加工温度 (Max Processing Temp): (230°C for 30~60 seconds)
 (260°C for 10 seconds)

接触材料 (Contact Material): 黄铜(Brass)
 塑胶材料 (Insulator Material): 尼龙(Nylon)-9T, UL 94V-0; 颜色: 黑色
 接触电镀 (Contact Plating): 镀金 (Gold plated)
 (电镀规格可根据客户要求来定制)
 Opitonal planting on request.

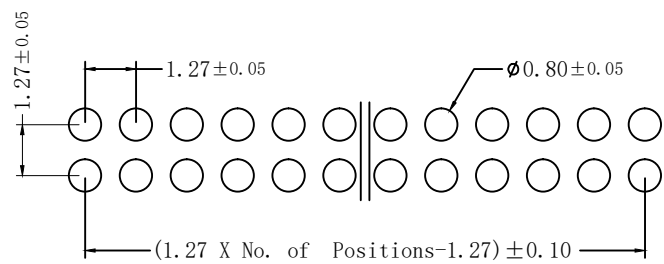

Recommended PCB Layout

公差:	版次:	A	 易芯精密科技(浙江)有限公司 Easychips Precision Technology (Zhejiang) Co., Ltd.	型号: EC127D-S-2*xxPG-A/B/C	签名	日期
. X ±0.35	比例:					
. XX ±0.25	单位:	mm	描述: 1.27双排直脚排针	绘图:		
. XXX ±2°	页码:	2/2	图号:	确认:		
LNLGB				审核:		