

目錄
MAPX

設變內容
MODIFICATION

日期
DATE

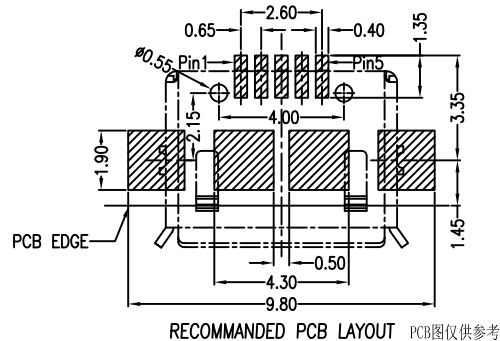
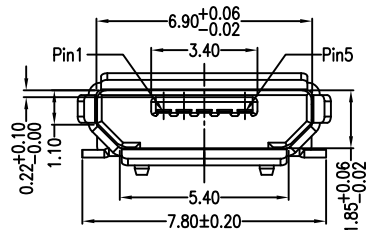
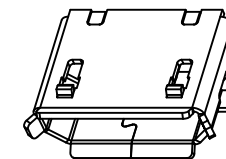
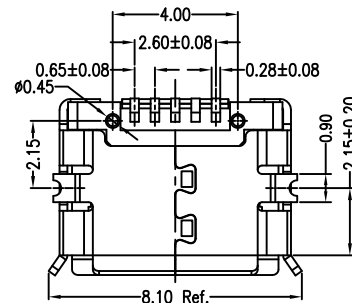
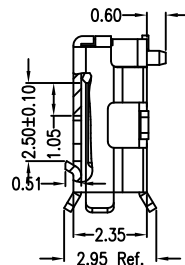
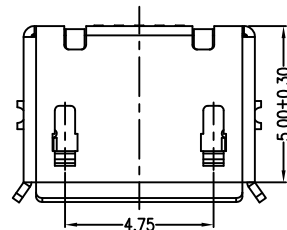
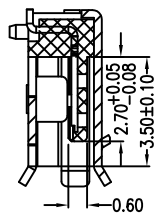
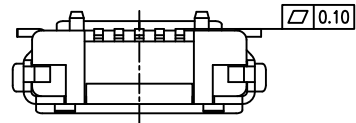

Note:

1.Material:

- 1.1 Housing: High temperature thermoplastic with g.f,UL94v-0
- 1.2 Contact: copper alloy,t=0.20mm
- 1.3 Shell: copper alloy,t=0.25mm

2.Specification:

- 2.1 Current rating:1,5PIN 1.8A Max/2,3,4PIN 1A Max.
- 2.2 Dielectric withstanding voltage: 100 V(ac) for 1 min.
- 2.3 Contact resistance: 30 mΩ Max.
- 2.4 Insulation resistance: 100 MΩ Min.
- 2.5 Total mating force: 3.57 Kgf Max.
- 2.6 Total unmating force: 1.0 Kgf Min
- 2.7 Temperature range: -30°C~80°C

产品图
PRODUCT CHART DWG



易芯精密科技(浙江)有限公司
Easychips Precision Technology (Zhejiang) Co., Ltd.

| 公差一览表 TOLERANCE UNLESS OTHERWISE | | | | 单位 UNITS | MM | 制图 DRAWING | 产品料号 PRODUCT PART NO. | | |
|-------------------------------------|-------|-------|-------|-------------|-----|---------------|--------------------------|--------------------------|------------|
| X. | ±0.25 | X' | ±5° | 比例 SCALE | 1:1 | 审核 CHKD | B920-ECD52A2021S10105 | | |
| .X | ±0.20 | .X' | ±2° | | | | 产品名称 PRODUCT NO. | MICRO 5S B型两脚贴板有边有柱短端SMT | |
| .XX | ±0.15 | .XX' | ±1° | | | | 日期 DATE | 2013/10/20 | 核准 APPD |
| .XXX | ±0.10 | .XXX' | ±0.5° | | | | 角法 VIEW | | 版本 VER |