

MAPX	MODIFICATION	DATE

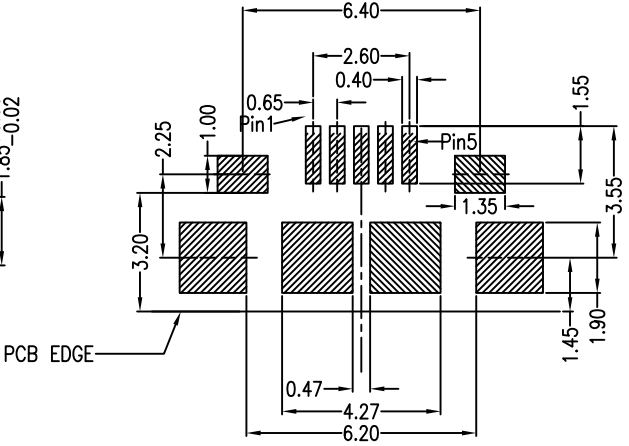
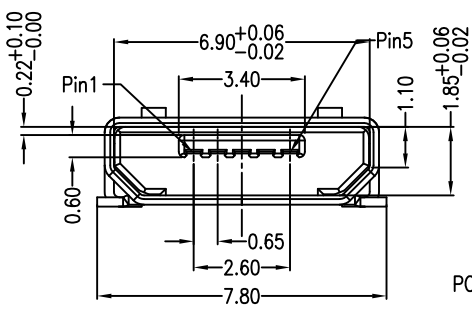
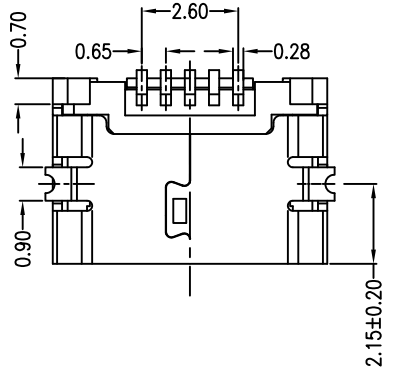
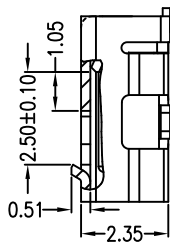
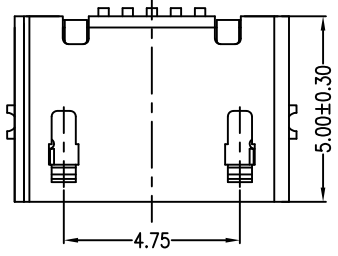
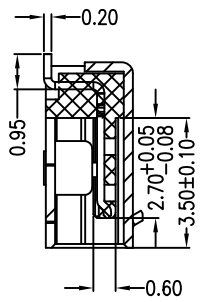
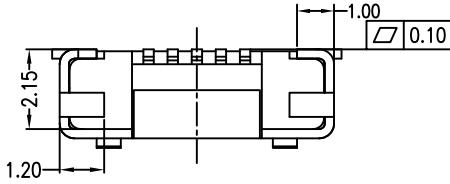

- Note:
- Material:
    - Housing: High temperature thermoplastic with g.f,UL94v-0
    - Contact: copper alloy,t=0.20mm
    - Shell: copper or sus304,t=0.25mm
  - Specification:
    - Current rating:1,5PIN 1.8A Max/2,3,4PIN 1A Max.
    - Dielectric withstanding voltage: 100 V(ac) for 1 min.
    - Contact resistance: 30 mΩ Max.
    - Insulation resistance: 100 MΩ Min.
    - Total mating force: 3.57 Kgf Max.
    - Total unmating force: 1.0 Kgf Min
    - Temperature range: -30°C~80°C

RECOMMENDED PCB LAYOUT PCB图仅供参考

<b>产品图</b> PRODUCT CHART DWG				<b>易芯精密科技(浙江)有限公司</b> Easychips Precision Technology (Zhejiang) Co., Ltd.					
公差一览表 TOLERANCE UNLESS OTHERWISE				单位	MM	制图	制图料号	B920-ECD62A2021S10104	
X	±0.30	X	±5.°	UNITS		DRAWING	PRODUCT PART NO.		
.X	±0.25	.X	±2.°	比例	1:1	审核	产品名称	MICRO 5P B型两脚贴板无边无柱加焊脚	
.XX	±0.15	.XX	±1.°	SCALE		核准	PRODUCT NO.	SMD加长0.2	
.XXX	±0.10	.XXX	±0.5°	日期	2021-04-16	APPD	角法	版本	AO
				DATE			VIEW	VER	